

Tuschierpresse
MILLUTENSIL
Designvorschlag
Variante Rund V01

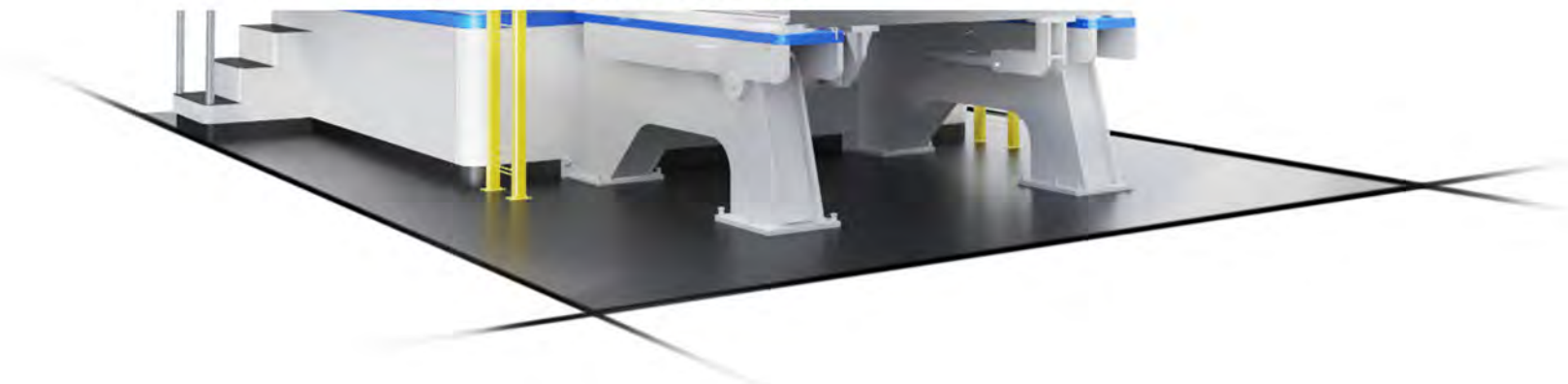

BROSSARDT

PRODUKTENTWICKLUNG



Bedienpult MILLUTENSIL History

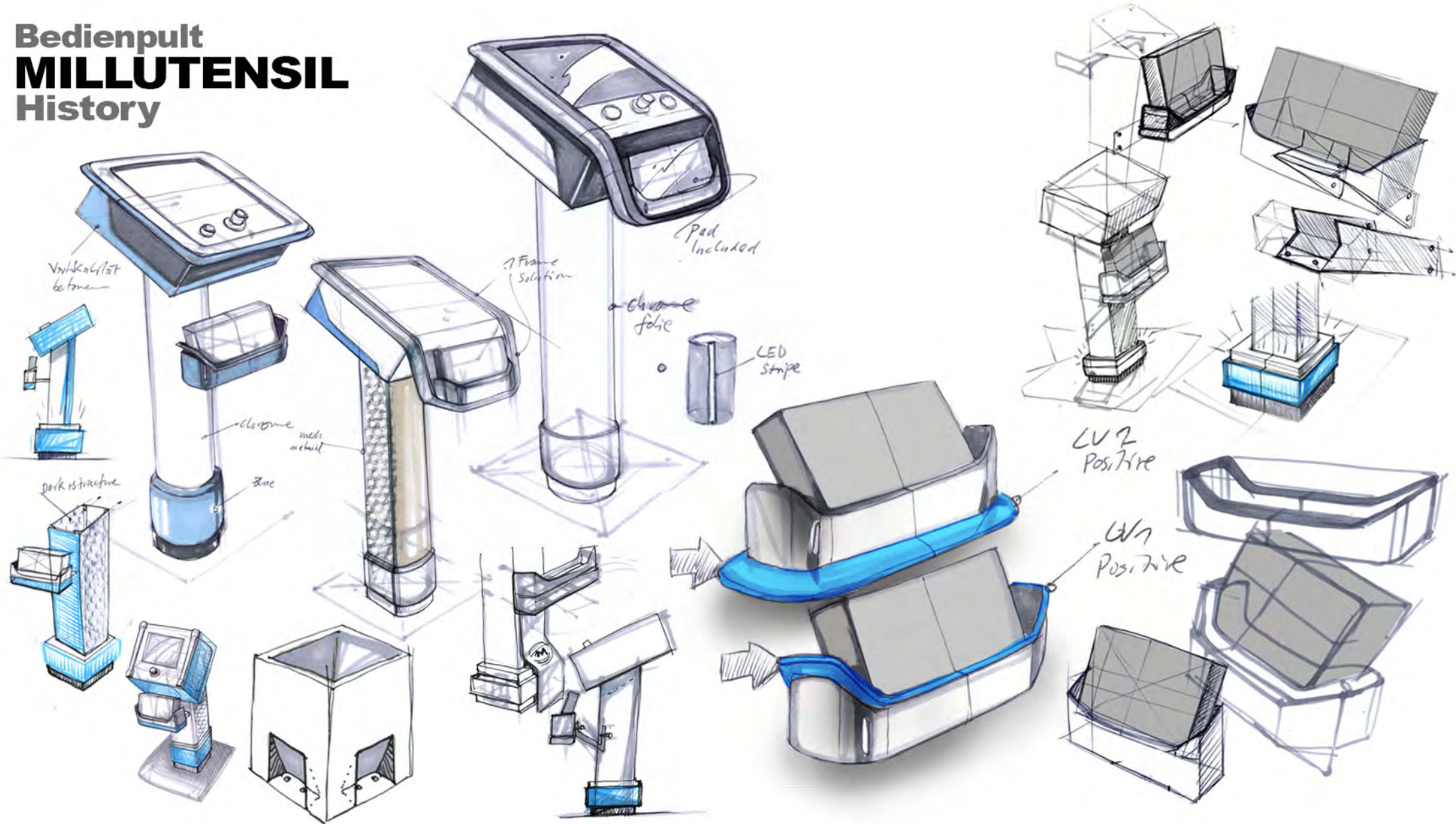

Bedienpult MILLUTENSIL Varianten



inspiration

one piece faceplate,
incl. pad mount
graphic variant



one piece faceplate,
separated pad mount
graphic variant



one piece faceplate,
separated pad mount
dark grey body
white LED line



Bedienpult
MILLUTENSIL
Varianten

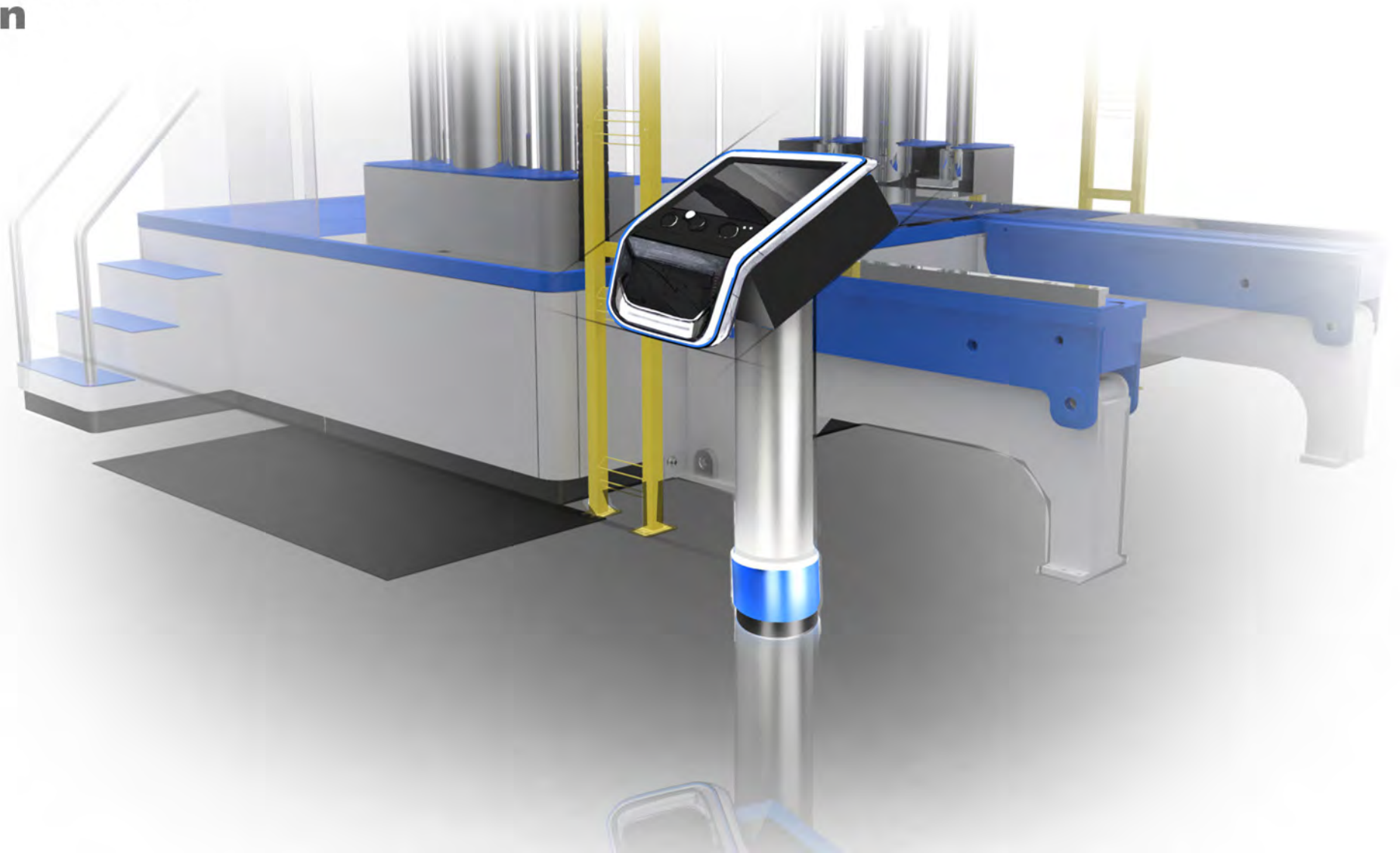

Rollwagen
MILLUTENSIL
Entwicklung



Rollwagen
MILLUTENSIL
Designvorschlag
Variante V1



Rollwagen **MILLUTENSIL** Designvorschlag Variante V1



Rollwagen MILLUTENSIL Designvorschlag Variante V2



Rollwagen
MILLUTENSIL
Designvorschlag
Variante V1



Rollwagen
MILLUTENSIL
Designvorschlag
Variante V1

unveränderte Bodenplatte



Bedienpult
MILLUTENSIL
Designvorschlag
Kombinierte Elemente V02



10 mm Stahlplatte + PU Soft Cover

Tuschierpresse
MILLUTENSIL
Designvorschlag
Variante Rund V01

- Logo zentriert

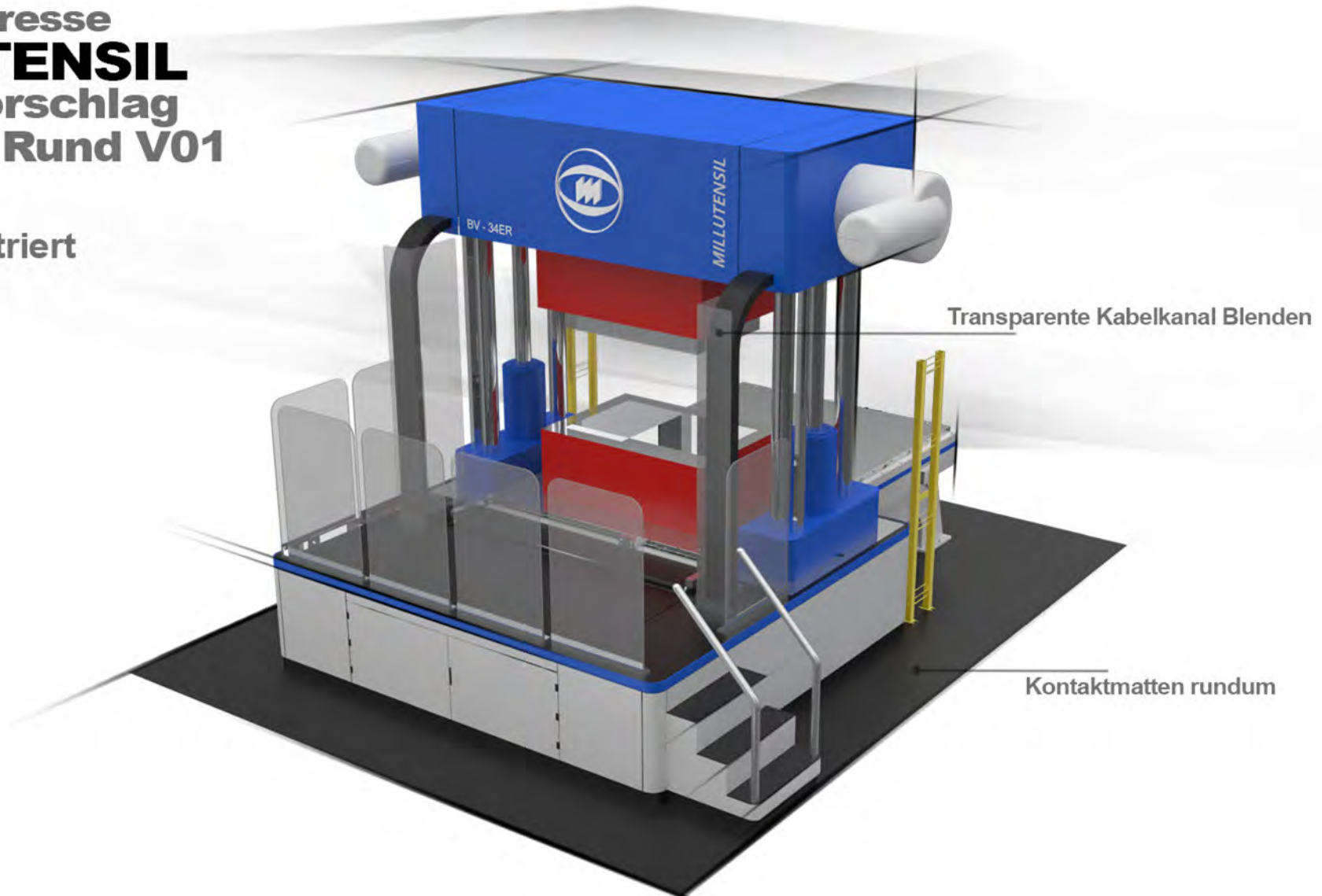

Bedienpult
MILLUTENSIL
Designvorschlag
Kombinierte Elemente V02



Bedienpult
MILLUTENSIL
Designvorschlag
Kombinierte Elemente V02



10 mm Stahlplatte + PU Soft Cover

Bedienpult
MILLUTENSIL
Designvorschlag
Kombinierte Elemente V02



Bedienpult
MILLUTENSIL
Designvorschlag
Kombinierte Elemente V02



10 mm Stahlplatte + PU Soft Cover

Bedienpult
MILLUTENSIL
Designvorschlag
Kombinierte Elemente V02

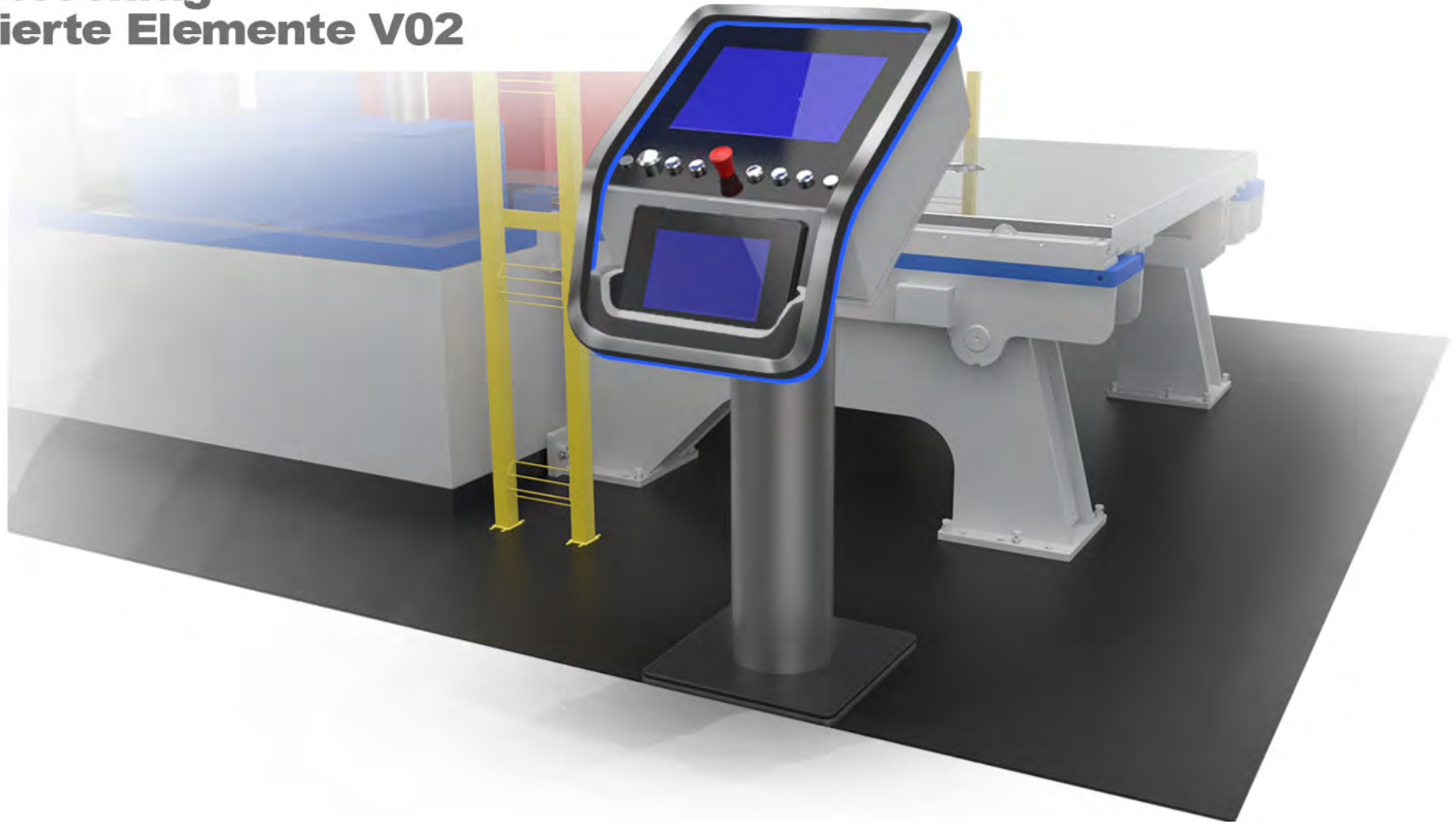

Bedienpult
MILLUTENSIL
Designvorschlag
Kombinierte Elemente V02

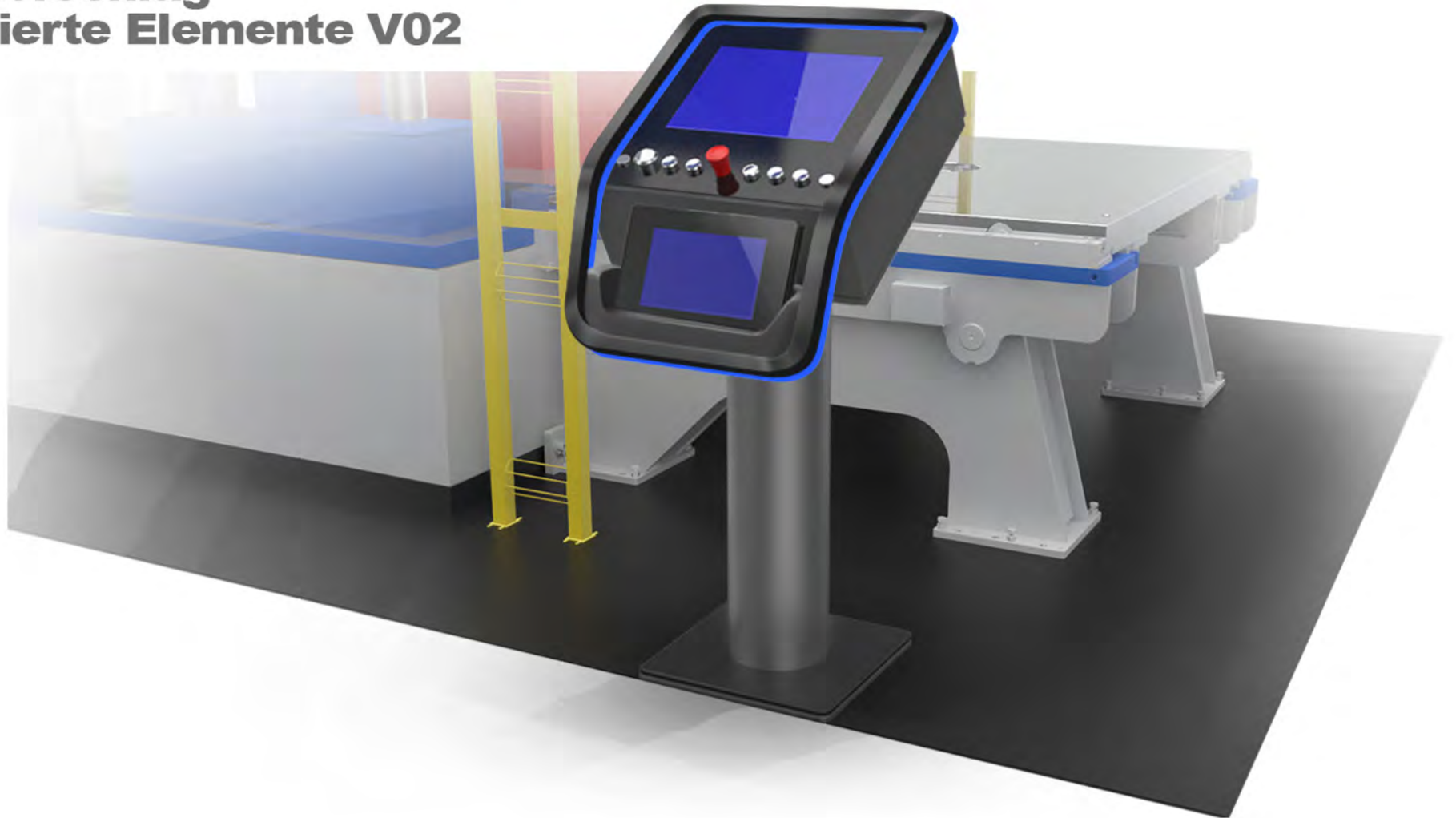

Tuschierpresse **MILLUTENSIL** Blue Line Designfamilie

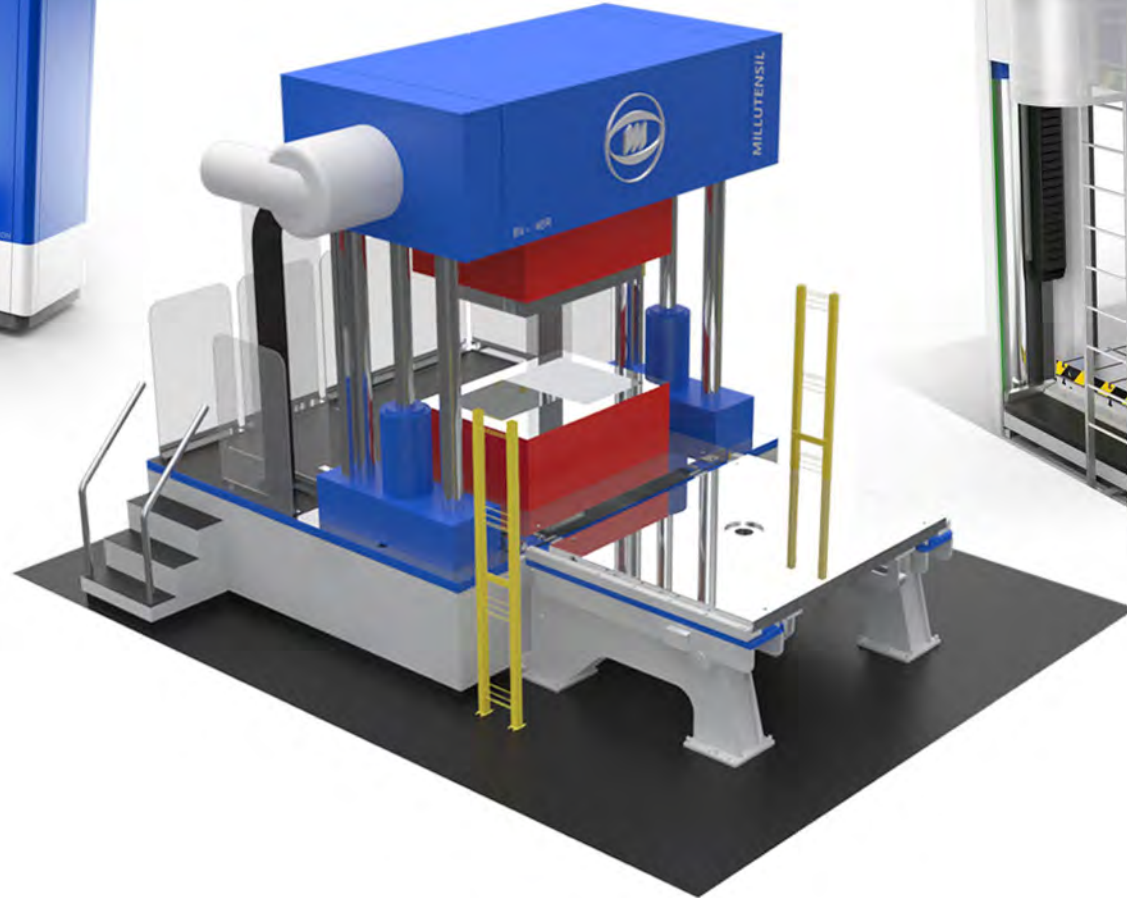

Tuschierpresse
MILLUTENSIL
Designvorschlag
Variante Eckig V01

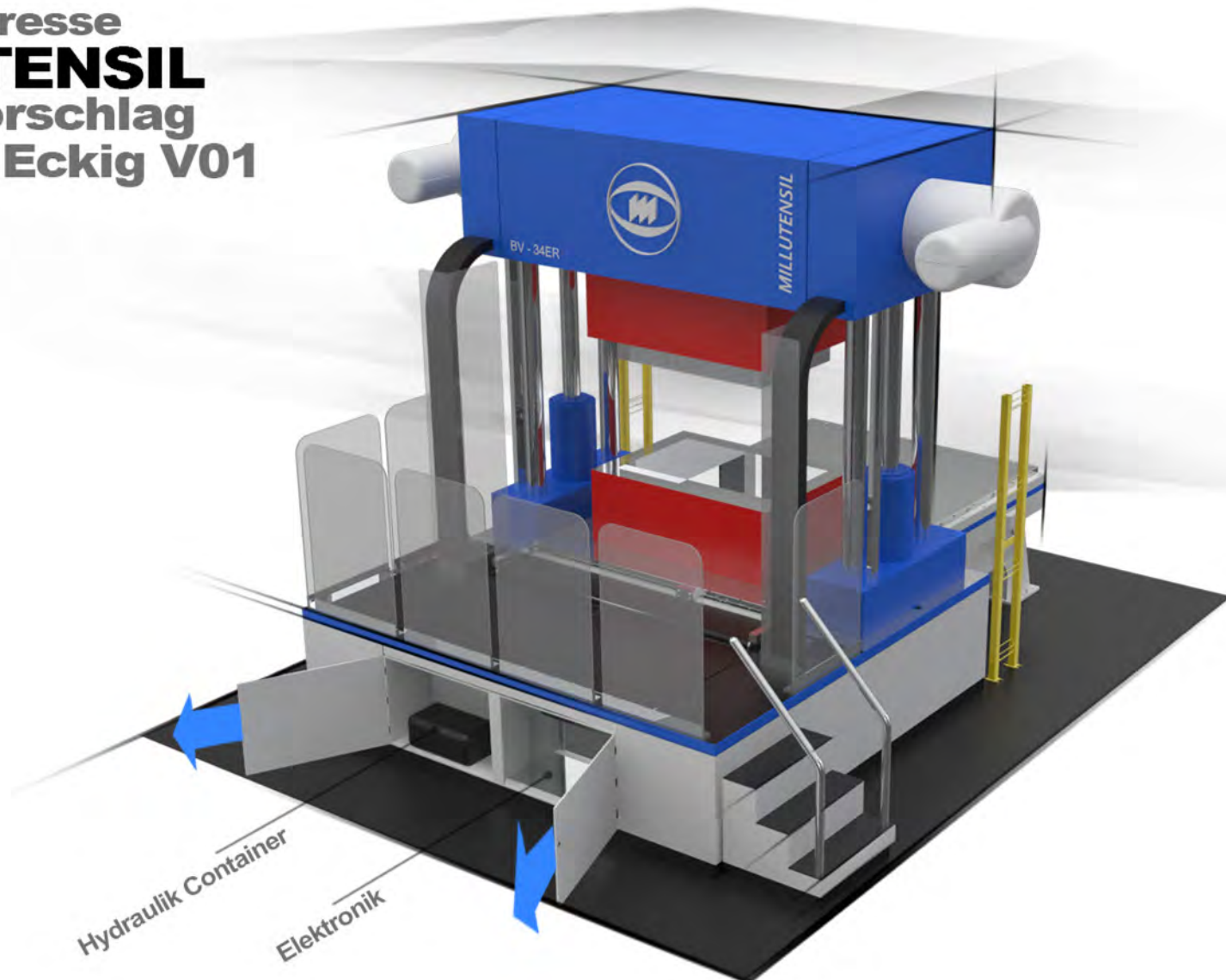

Bedienpult MILLUTENSIL Entwicklung

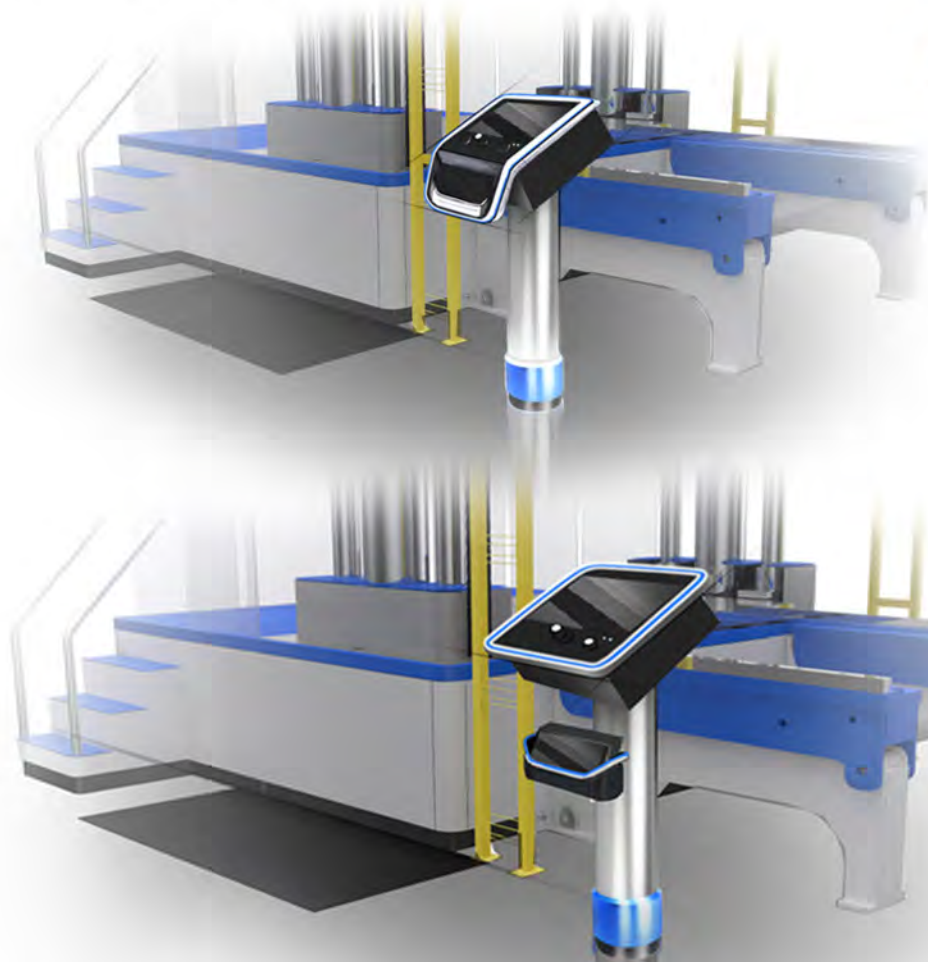

one piece faceplate,
incl. pad mount
graphic variant



one piece faceplate,
separated pad mount
dark grey body
white LED line



one piece faceplate,
separated pad mount
graphic variant



Tuschierpresse
MILLUTENSIL
Designvorschlag
Variante Eckig V01

- Aktiver Zustand

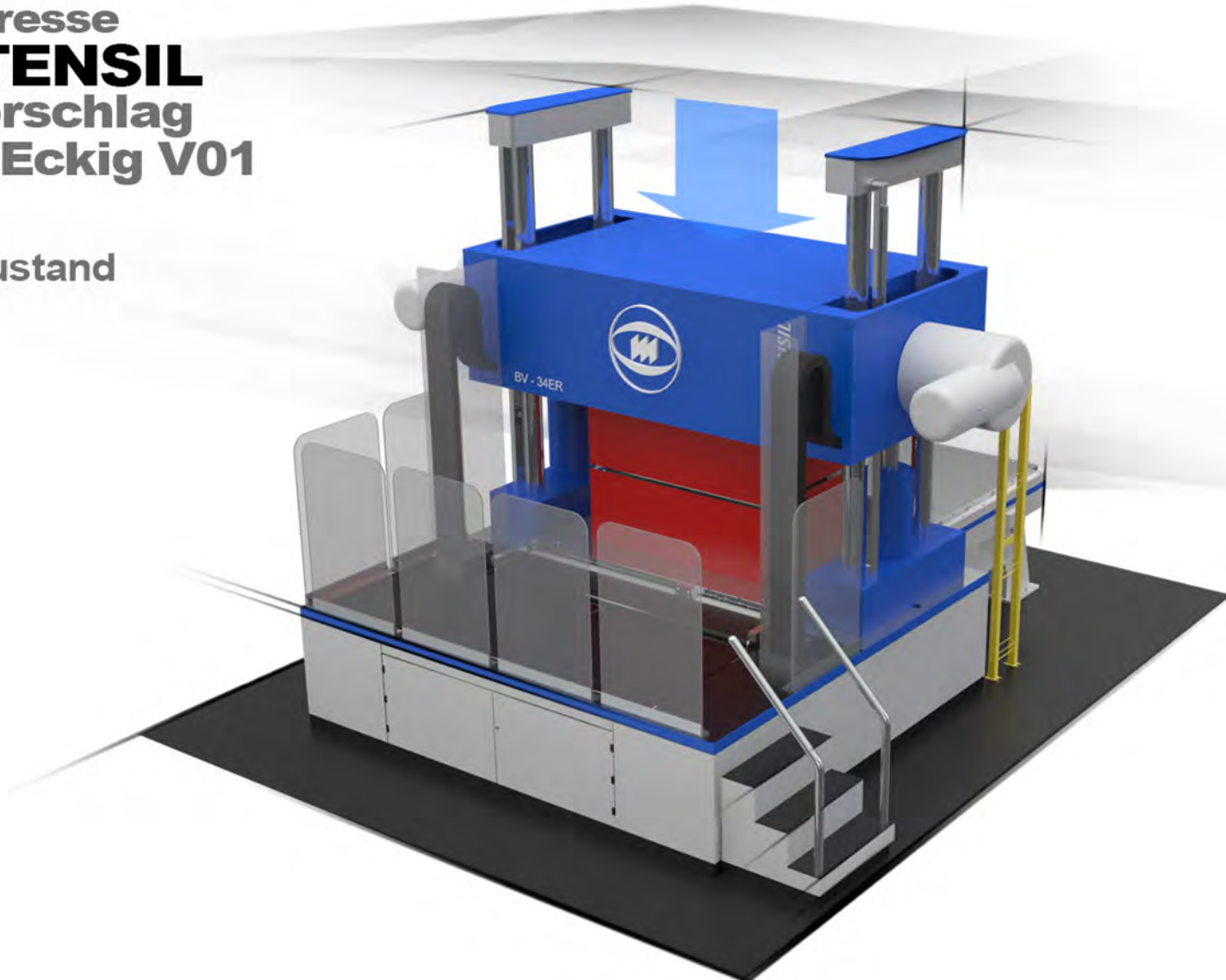

Tuschierpresse
MILLUTENSIL
Designvorschlag
Treppenmodul

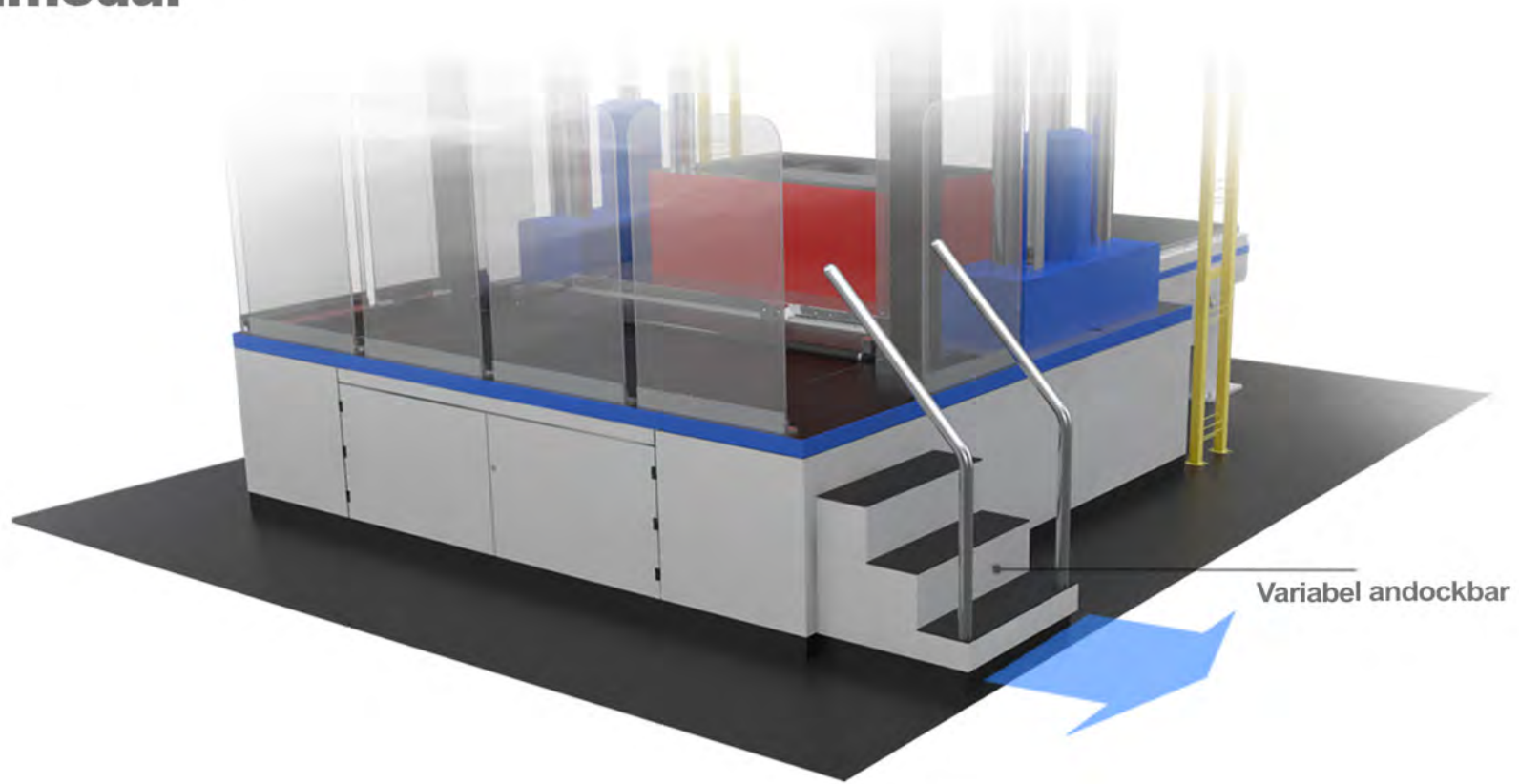

Tuschierpresse
MILLUTENSIL
Designvorschlag
Treppenmodul

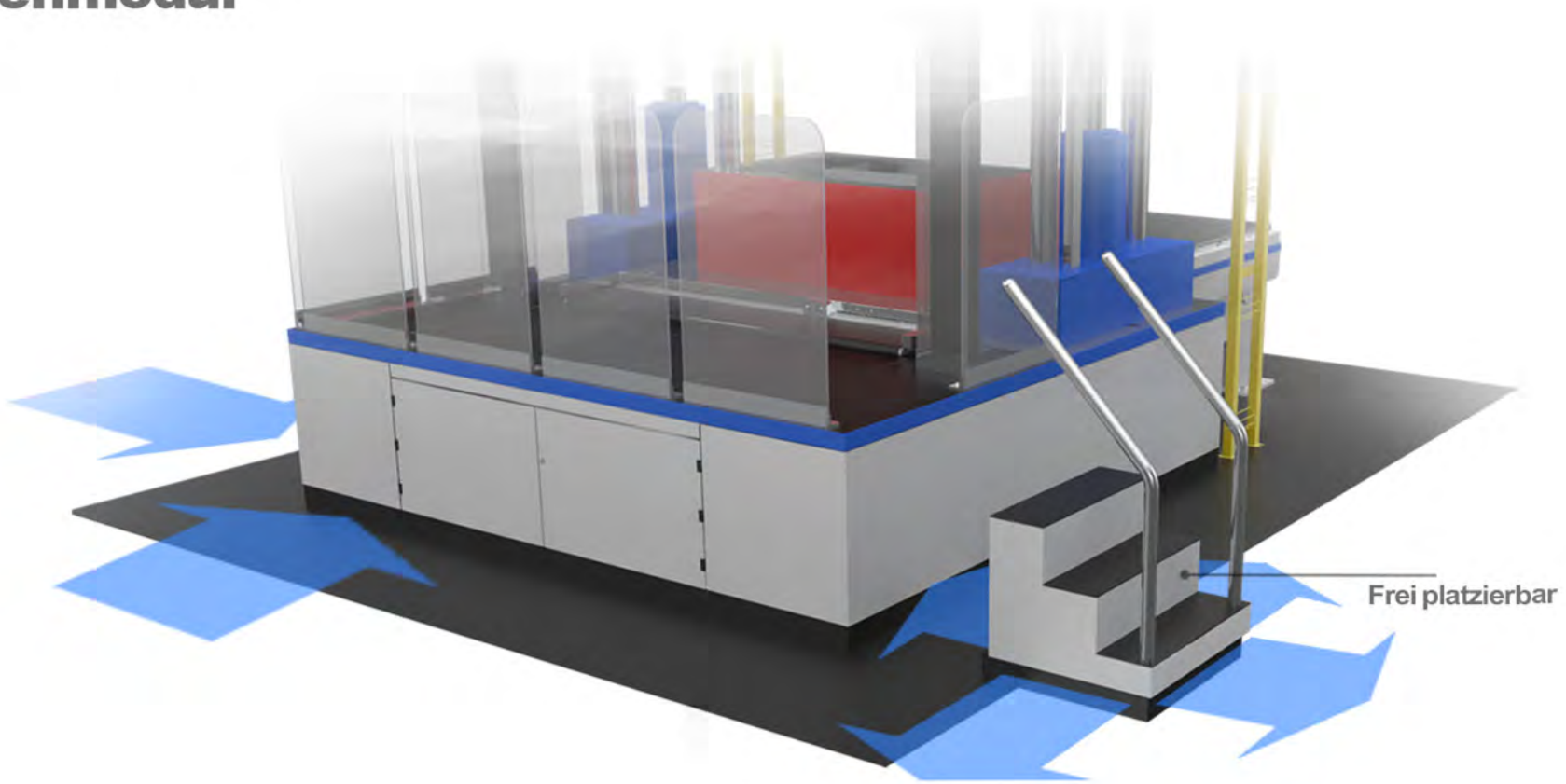

Frei platzierbar

Tuschierpresse
MILLUTENSIL
Darstellungen

